



Ellesmere

Standard Model

Electric Stove



INSTALLER: LEAVE THIS MANUAL WITH THE APPLIANCE.

CUSTOMER: PLEASE RETAIN THIS MANUAL FOR FUTURE REFERENCE.

For use in GB & IE (United Kingdom and Ireland)

Document No. : RH/ELEC/ELL/AS/AM – Iss 02/01/2020

File: Ellesmere Electric ECE-AS Standard_User_Man.doc



TABLE OF CONTENTS

Please read and carefully follow all of the instructions found in this manual. Please pay special attention to the safety instructions provided in this manual. The instructions included here will assure that you have many years of dependable and enjoyable service from your AGA Electric Stove.

PURCHASE, INSTALLATION INFORMATION & HEALTH & SAFETY	3
ELECTRICAL SAFETY TEST CERTIFICATE	6
IMPORTANT INSTRUCTIONS	7
THE DO'S & DON'Ts	8
STOVE DIMENSIONS	9
INSTALLATION ONTO A NON-COMBUSTIBLE HEARTH	10
UNPACKING AND TESTING APPLIANCE	12
WHAT COMES WITH THE STOVE	13
FITTING THE REAR WALL FIXING BRACKET	14
SETTING UP THE LOG SET & MEDIA	17
LOG SET - SAMPLE LAYOUT	18
OPERATING YOUR STOVE – UNDERSTANDING THE ICONS	20
MANUALLY OPERATING THE STOVE – INSTRUCTIONS	22
REMOTE CONTROL OPERATION – INSTRUCTIONS	23
STOVE RESET SEQUENCE	27
CARE AND MAINTENANCE	27
EXPLODED VIEW & PARTS LISTS	28
TROUBLE SHOOTING	30
SERVICE HISTORY	31
WARRANTY	32

SAFETY INFORMATION



WARNING

If the information in these instructions is not followed exactly, a fire or explosion may result causing property damage, personal injury or loss of life.

Do not store or use Petrol or any other flammable vapors and liquids in the vicinity of this or any other



PURCHASE & INSTALLATION INFORMATION

Please complete the following form for reference when required:

Ref.	Description	Please Complete
1	Which retailer did you purchase the stove from?	Name & Address of Retailer:
2	What date did you purchase your new stove?	Purchase Date:
3	What was the name of the person who installed your stove?	Full Name: Contact Number:
5	What is the serial Number of your stove? <i>This can be found inside the front door above the bottom hinge</i>	Serial Number:
6	What date was your stove installed?	Installation Date:
7.	The AGA Name, Model & Type reference for this stove is	Name - Ellesmere Standard Model – ELL/ELEC/A5S Type – Electric

Technical Data Summary:

Reference	Description	Data
1	Maximum Heat Output	1.9 kW - (Equivalent to approx. 6,500 BTU's)
2	Minimum Heat Output	950 Watts
3	Flame Only Effect - LED Lights	25 watts - (Power Consumption)
4	Fuse Size inside 3 Pin Plug	10 Amp Rating

AGA Reference Code:

Model Code Reference - ELL/ELEC/A5S



HEALTH & SAFETY REQUIREMENTS – PLEASE READ

1. If the electricity supply cable is damaged do not use the appliance until it has been replaced. For safety reasons the replacement has to be carried out by a service agent or a similarly competent electrician.
2. Caution: in order to avoid a hazard due to inadvertent resetting of the thermal cut out, this appliance must not be supplied through an external switching device, such as a timer, or connected to a circuit that is regularly switched on and off by the utility
3. Do not operate the appliance if it is damaged.
4. Repairs of electrical appliances must only be performed by a suitably qualified electrical engineer. Should the appliance fail to operate, or in case of any damage, please contact the retailer from whom the appliance was purchased.
5. Caution: some parts of this product can become very hot and cause burns. Particular attention must be given where children and vulnerable people are present.
6. **This appliance can only be used by children aged from 8 years and above and persons with reduced physical, sensory or mental capabilities or lack of experience and knowledge if they have been given supervision and/or instruction concerning use of the appliance in a safe way and understand the hazards involved. However if you do not deem the child or person competent only allow them to operate the stove when a competent adult is in the room to supervise**
7. **CHILDREN OF LESS THAN 8 YEARS SHOULD BE KEPT AWAY UNLESS CONTINUOUSLY SUPERVISED BY A COMPETENT ADULT.**

If you are installing your appliance in to an existing chimney cavity

- **This stove MUST be installed on a Non Combustible Hearth - Ensure the floor area the stove will sit on is flat and free from any loose materials**
- **If applicable - if being fitted into a chimney opening ensure the flue has been fully swept out, the chimney cavity should be sealed but an air vent must be fitted so there can be a free flow air into the flue**
- **To provide power to the appliance instruct a qualified electrician to install an earthed power socket behind the stove unless one is already there. Ensure this socket can be electrically isolated with a switch which is accessible, this must be connected to the 13 amp ring main of the house and covered by a RCB breaker**
- **Must not be installed into a room with steam and water ingress such as a Kitchen or Bathroom or a Wet Room**
- **When installing & operating this stove there must be a free flow of air all around the complete stove so a free flow of air can enter the rear air vent of the stove without any restriction**



HEALTH & SAFETY REQUIREMENTS – PLEASE READ

- **Never leave children unsupervised with an unguarded heater.**
- **Never obstruct or cover the Stove or the heater Air Inlet and Outlet.**
- **Never install or use this product where it may come in contact with water, moisture or Steam i.e. Kitchen, Bathroom or Wet Room.**
- **Never use aerosols or steam cleaners near this product.**
- **Never route the electric cable near the heater outlet.**
- **Never route the electric cable under carpets or floor coverings.**
- **Never install this product close to curtains or any combustible materials.**
- **Never use the heater to dry clothes or other objects.**
- **Never remove the stove from the fireplace without isolating the electric supply, ensure this stove is EARTHED**



This AGA Electric Stove has been fully tested and CE Approved in the UK by KIWA Blackwood Compliance Laboratories, a leading European Test Agency



Electrical Safety Test Certificate

Manufacturer: AGA Rangemaster

Product Name/Model: Ellesmere Standard Electric Stove ELL/ELEC/A5S
Description: Room heater

Certificate Number: C 19-4649B

Test Standards: EN 60335-2-30:2009 + A11:2012
 EN 60335-1:2012 + A11:2014 + A13:2017



Tested at: Kiwa Blackwood Compliance Laboratories
 Blackwood, NP12 2DG,
 United Kingdom

CONFORMITY WITH DIRECTIVES

This stove conforms to all relevant European Directives and is fully CE Compliant



		DO NOT COVER THIS APPLIANCE OR BLOCK THE FRONT OR REAR HEAT VENTS		IP RATED – IPX0 ELECTRIC ROOM HEATER
AGA RANGEMASTER STATION ROAD, KETLEY, TELFORD, TF1 5AQ WWW.AGASTOVES.CO.UK		MUST BE FITTED ONTO A NON-COMBUSTIBLE HEARTH		 COUNTRY OF DESTINATION GB & IE NOT FOR USE IN BATHROOMS OR ANY WET ENVIRONMENTS
MODEL NO. ELL/ELEC/A5S		DESCRIPTION - ONLY FOR USE AT 240V - AC 50 Hz ELLESMERE ELECTRIC STANDARD MODEL		
<small>SEE PLATE FOR SERIAL NO</small>	HIGH HEAT	LOW HEAT	FLAME EFFECT	WARNING DISCONNECT FROM THE MAINS BEFORE SERVICING THIS PRODUCT
POWER INPUT	10 Amps/1900w	10 Amps/950w	25 WATTS	
NET EFFICIENCY (%)	100%	100%	N/A	
NET HEAT OUTPUT	1.9kW/6500BTU	950 watts	N/A	
STOVE REF.	MIN. DISTANCE TO COMBUSTIBLES		MIN. DISTANCE TO NON-COMBUSTIBLES	
REAR	100 mm		75 mm	
SIDES	100 mm		75 mm	
TOP	400 mm		400 mm	
FRONT	1000 mm – WARNING HOT ZONE		1000 mm – WARNING HOT ZONE	
THIS APPLIANCE IS CAPABLE OF INTERMITTENT OPERATION AND SHOULD ONLY BE USED & INSTALLED IN ACCORDANCE WITH THE MANUFACTURERS USER'S OPERATING & INSTALLATION INSTRUCTIONS				
CLEAN FRONT HEAT OUTPUT & REAR AIR INTAKE VENTS REGULARLY				

CE Plate - Fixed to the Rear of the Stove (Not to Scale)



IMPORTANT INSTRUCTIONS

1. Read all instructions before installing or using this heater.
2. **DO NOT COVER THIS STOVE IN ANY WAY WHAT SO EVER**
3. **THIS STOVE MUST BE FITTED ONTO A NON COMBUSTIBLE HEARTH, WHICH EXTENDS 225MM PAST THE FRONT OF THE STOVE &100MM TO THE REAR.**
4. **DO NOT BLOCK THE COOL AIR INLET AT THE REAR OR THE HOT AIR OUTLET AT THE FRONT**
5. **ENSURE NO FOREIGN BODIES BLOCK THE COOL AIR INLET AT THE REAR OR THE HOT AIR OUTLET AT THE FRONT OF THIS STOVE (SUCH AS PET HAIRS CARPET FLUFF ETC) REGULARLY CLEAN ANY DUST, FIBRES OR DEBRIS FROM THESE VENTS AT THE FRONT AND BACK OF THE STOVE**
6. Keep combustible materials, such as furniture, pillows, bedding, papers, clothes and curtains at least 1000mm (39 inches) from the front, sides and rear of the heater.
7. Ensure the rear mounting bracket is fitted before opening the door, otherwise the stove could tip forward
8. Always unplug (3 pin plug) heater when not in use.
9. Do not operate the fireplace if it has a damaged cord or plug, after it has malfunctioned, or if the unit has been dropped or damaged in any way.
10. Do not use the heater outdoors.
11. Do not run the cord under carpeting. Do not cover the cord with throw rugs, runners or anything else. Arrange the cord away from traffic areas where it could cause a tripping hazard.
12. To disconnect the heater, turn the controls to "OFF" before removing the plug from the outlet.
13. Do not insert or allow foreign objects to enter any ventilation or exhaust opening, as this may cause an electric shock, fire or damage to the heater.
14. **To prevent a possible fire, do not block air intakes in any way.**
15. A heater has hot and arcing or sparking parts inside. Do not use it in areas where petrol/gasoline, paint or flammable liquids are used or stored.
16. Use this heater only as described in this manual. Any other use not recommended by the manufacturer may cause fire, electric shock or injury.
17. Avoid the use of an extension cord, the extension cord could overheat and cause a fire. This heater is not to be used with an extension cord.
18. Always use properly grounded fused and polarized outlets.
19. Always use ground fault protection where it is required by electrical codes.
20. Always disconnect the power before performing any cleaning, maintenance or relocation of the heater.
21. To prevent a possible fire, do not burn wood or other materials in this heater.
22. To prevent electric shock or fire, always use a certified electrician, should new circuits or outlets be required.
23. When transporting or storing the heater, keep it in a dry place, free from excessive vibration.
24. This appliance should not be modified under any circumstances.
25. Packaging material should be kept away from children and be disposed of in a safe manner. Plastic bags are not toys and should be kept away from children and infants.



26. Do not use this heater in small rooms when they are occupied by persons not capable of leaving the room on their own, unless constant supervision is provided.
27. If the glass is damaged, do not use the heater in order to avoid a hazard.
28. Do not leave children unsupervised when heater is turned on.
29. **CAUTION** Some parts of this product can become very hot and cause burns. Particular attention has to be given where children and vulnerable people are present.
30. This appliance can be used by children aged from 8 years and above and persons with reduced physical, sensory or mental capabilities or lack of experience and knowledge if they have been given supervision or instruction concerning use of the appliance in a safe way and understand the hazards involved. Children should not play with the appliance. Cleaning and user maintenance shall not be made by children without supervision.

The DO's & DON'Ts

DO's	DO INSTALL THIS STOVE ONTO A NON COMBUSTIBLE HEARTH, WHICH EXTENDS 225MM PAST THE FRONT OF THE STOVE.
	<ul style="list-style-type: none"> • CLEAN THE INLET & OUTLET VENTS REGULARLY AT LEAST ONCE A WEEK DEPENDING ON OPERATING CONDITIONS TO REMOVE ANY DUST, FIBRES OR DEBRIS (SUCH AS PET HAIRS & CARPET FLUFF ETC) • Always install the heater in accordance with this guide. If in doubt obtain expert advice • Always make sure the electrical socket is accessible and located adjacent to, but not above the heater. • Always disconnect the heater from the electrical supply before moving it, or carrying out cleaning, maintenance. • Always make sure the heater is firmly secured to prevent it from being tipped over, using the rear fixing bracket • Always use a fireguard when young children and infirm persons can come into contact with the heater.
DON'Ts	• NEVER COVER THIS STOVE IN ANY WAY WHAT SO EVER
DON'Ts	• NEVER BLOCK THE COOL AIR INLET AT THE REAR OR THE HOT AIR OUTLET AT THE FRONT
DON'Ts	• NEVER ALLOW FOREIGN OBJECTS TO BLOCK THE COOL AIR INLET AT THE REAR OR THE HOT AIR OUTLET AT THE FRONT OF THIS STOVE (SUCH AS PET HAIRS & CARPET FLUFF ETC)
DON'Ts	<ul style="list-style-type: none"> • Never leave children unsupervised in a room where the heater is ON and unguarded. • Never obstruct or cover the fan outlet or force items into heater openings. • Never install or use the heater anywhere where water is in use, i.e. Bathroom, Kitchens, Shower Rooms, Swimming Pool etc. • Never use aerosols or steam cleaners on or around the heater. • Never route the mains supply cable under carpet etc. • Never install the heater close to curtains or combustible materials. • Never use the heater to dry clothes etc. • Never sit or stand on the heater. • Never use with a timer or any other device that switches the fire on automatically.

STOVE DIMENSIONS

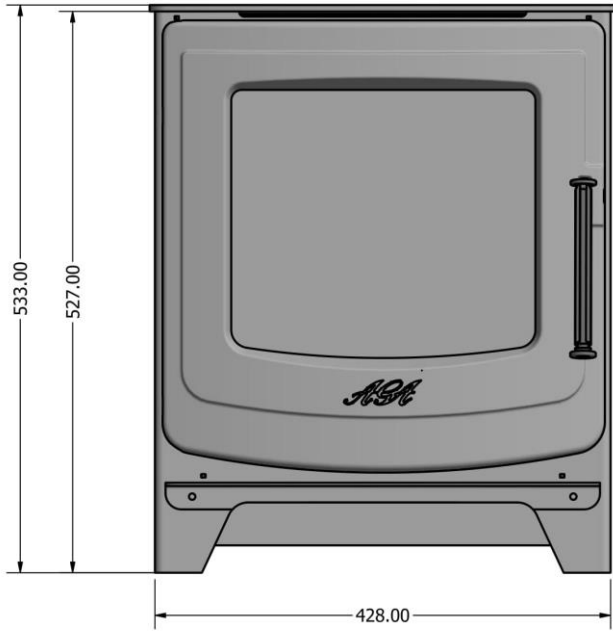

Front View

Manual Controls and the ON/OFF Switch

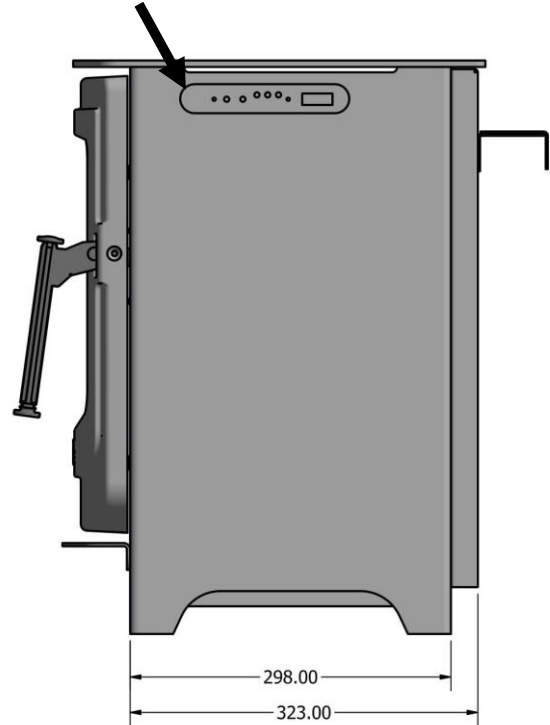

Right Hand Side View

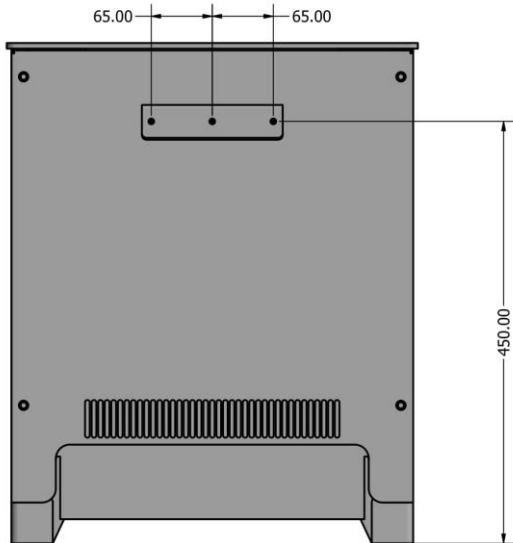

Rear View

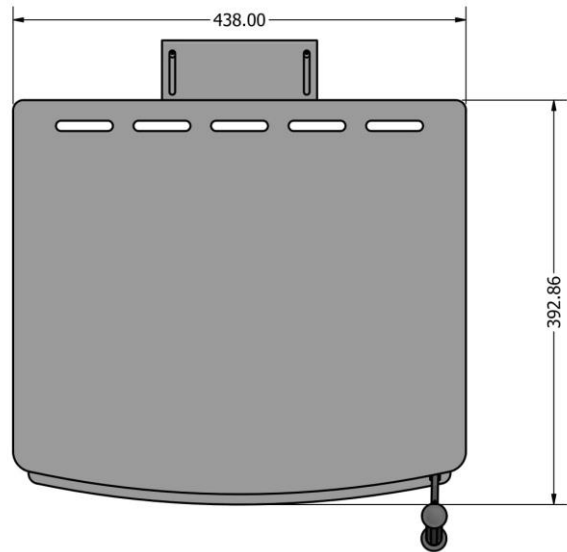

Top View

Drawings are Not to Scale

INSTALLATION MUST BE ONTO A NON-COMBUSTIBLE HEARTH

(Hearth is shown as thick Black Line below)

Drawing Not to Scale

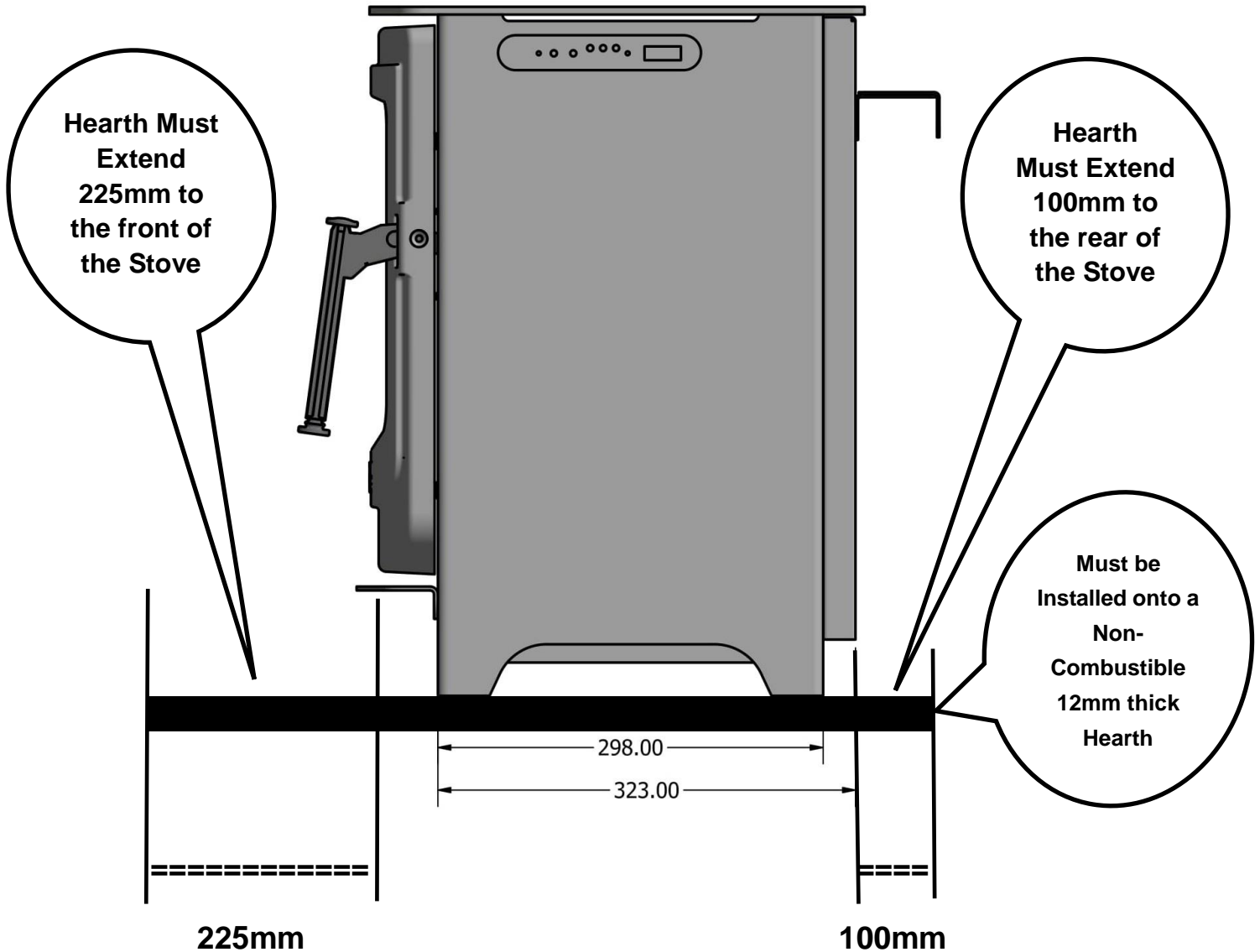

This stove must be fitted on to a Non Combustible Hearth with a minimum thickness of 12mm, which extends:

- 225mm from the front of the door of the stove
- Minimum of 100mm from the rear of the stove
- Minimum of 75mm either side of the stove

DO NOT COVER THIS STOVE – this will void the warranty

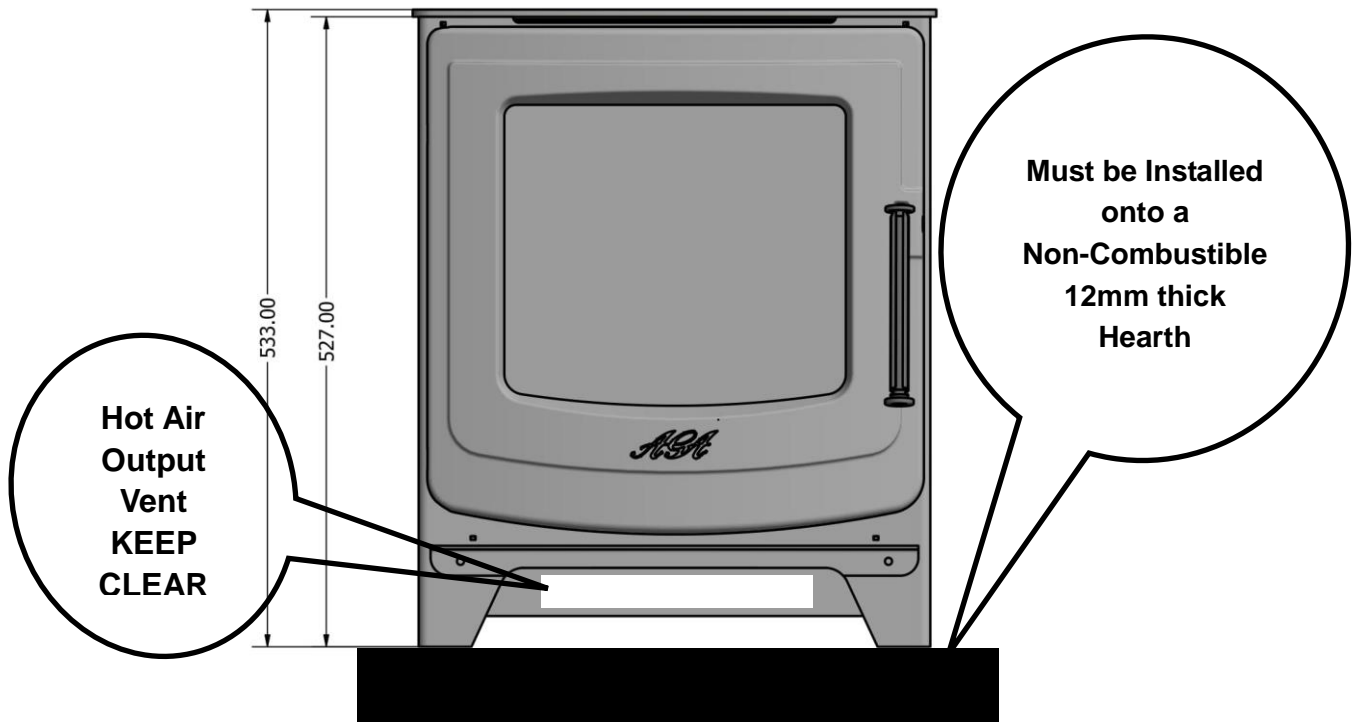

Above Front View - Hot Air Output Grill must be kept clear– shown in white box above

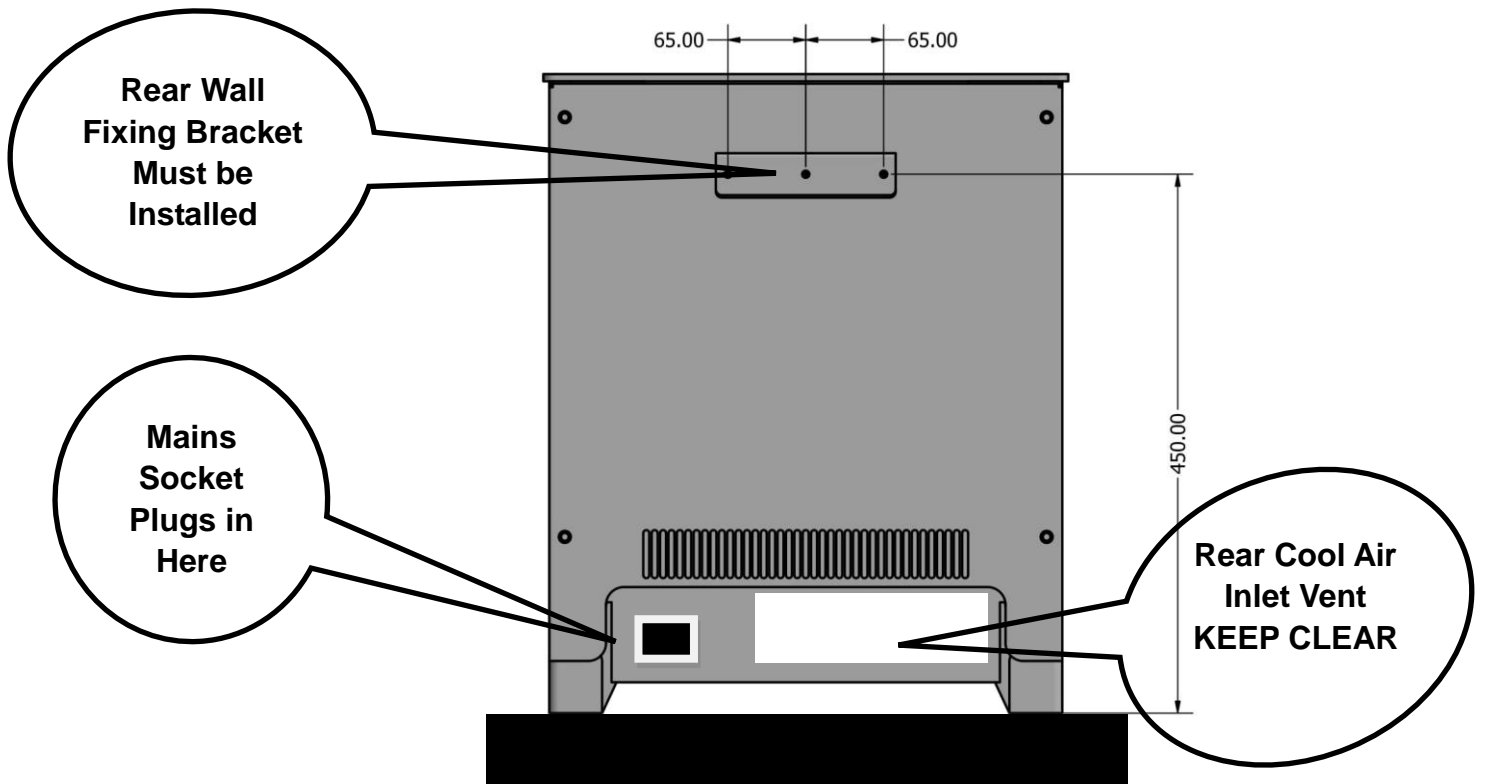

Rear View - Cool Air Intake Grill shown in white box above, this must be kept clear of any foreign objects such as Pet Hairs and Carpet Fluff, this must be regularly cleaned so the vents are clear of foreign objects, such as dust, debris and fibres.



UNPACKING AND TESTING APPLIANCE

Carefully remove the appliance from the box.

Prior to installing the appliance, test to make sure the appliance operates properly by plugging the power supply cord in the socket on the back of the stove and then directly into a 240 Volt wall socket (not an extension lead or a multi-plug in a wall socket)

Test all aspects of its operation (manual switches, remote and heater) to make sure all components are operating correctly.

As with most electronic devices, your new electric stove has been designed to operate at temperatures between 5°C (41°F) and 35°C (95°F). During the cold winter months, allow the stove to reach a minimum room temperature of 5°C before turning it on.

NOTE: There may be a trace of odour during the first time you use this stove. This is caused from the paint finish curing, if the smell is strong open the windows and operate the stove on the full heat setting for 30 to 45 minutes to allow the paint to cure, children, the elderly or pets should not be allowed into the room during this period

WARNING – ELECTRIC SHOCK HAZARD

It is the customers responsibility to contact a qualified electrical installer to make sure the electrical installation is adequate and in conformance with the regulations. Take special care when cutting holes in walls or floor. Electrical wires may be behind the wall or floor covering and could cause an electrical shock if you touch them. Locate any electrical circuits that could be affected by the installation of this product and disconnect power circuit

WARNING: THIS APPLIANCE MUST BE EARTHED.

DO NOT use an extension lead with this appliance. The appliance is designed for the voltage stated on the CE data plate. Recommended but not mandatory to fit an individual Residual Current Device (RCD) to the ring main supply circuit to this stove. Please Hand this Manual to the customer/User for retention and future instructions in the safe operation of the appliance.

WHAT COMES WITH THE STOVE

- 1 - Media Pack consisting of Logs and Embers – please refer to the Media Section
- 2 - Remote Control
- 3 - 2 x AAA Batteries - packed separately
- 4 - Power Cord with 3 pin sealed plug fitted – 10 AMP fuse fitted
- 5 - Wall Fixing Bracket – please note this is already fitted to the rear of the stove



Item 2 – Remote Control



Item 3 - Batteries



Item 3 – Power Code



Item 1 - Log Media Pack includes the following:

- 11 x Piece Log set – various sizes
- Large bag of Glass Amber Bead Embers
- Small bag of White Vermiculite Chippings
- Small bag of Black Vermiculite Chippings

All of the items are packed into this cardboard box

In the box is

- Item 1 - Log Media Pack
- Item 2 - Remote Control
- Item 3 - 2 x AAA Batteries
- Item 4 - Power Cable

FITTING THE REAR WALL FIXING BRACKET

This bracket must be fitted to the rear of the stove to ensure that the stove will not tip forward when the stove door is opened

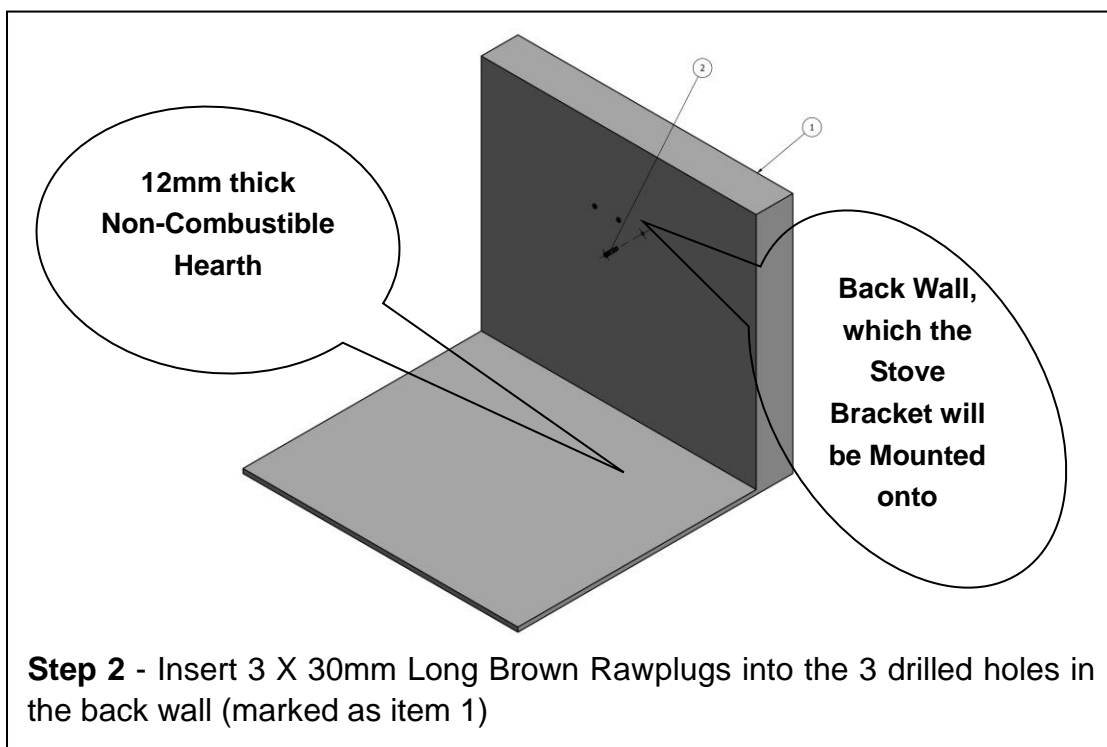
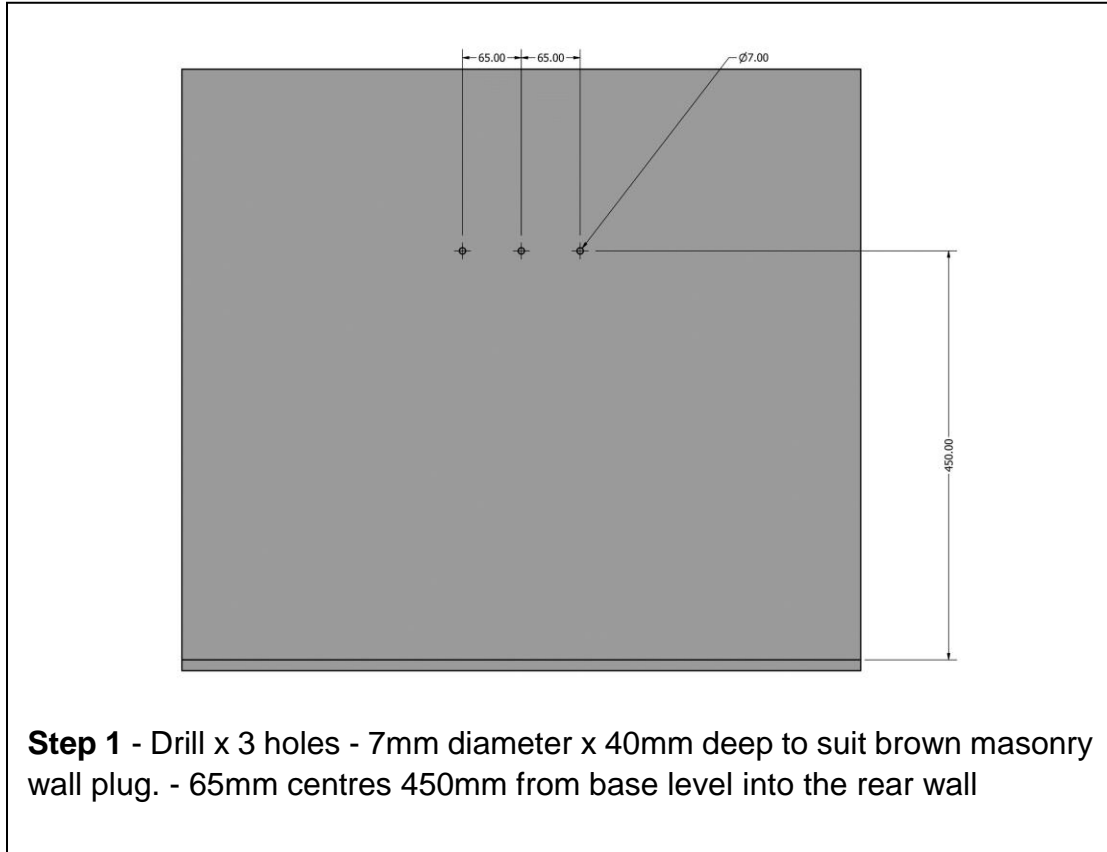

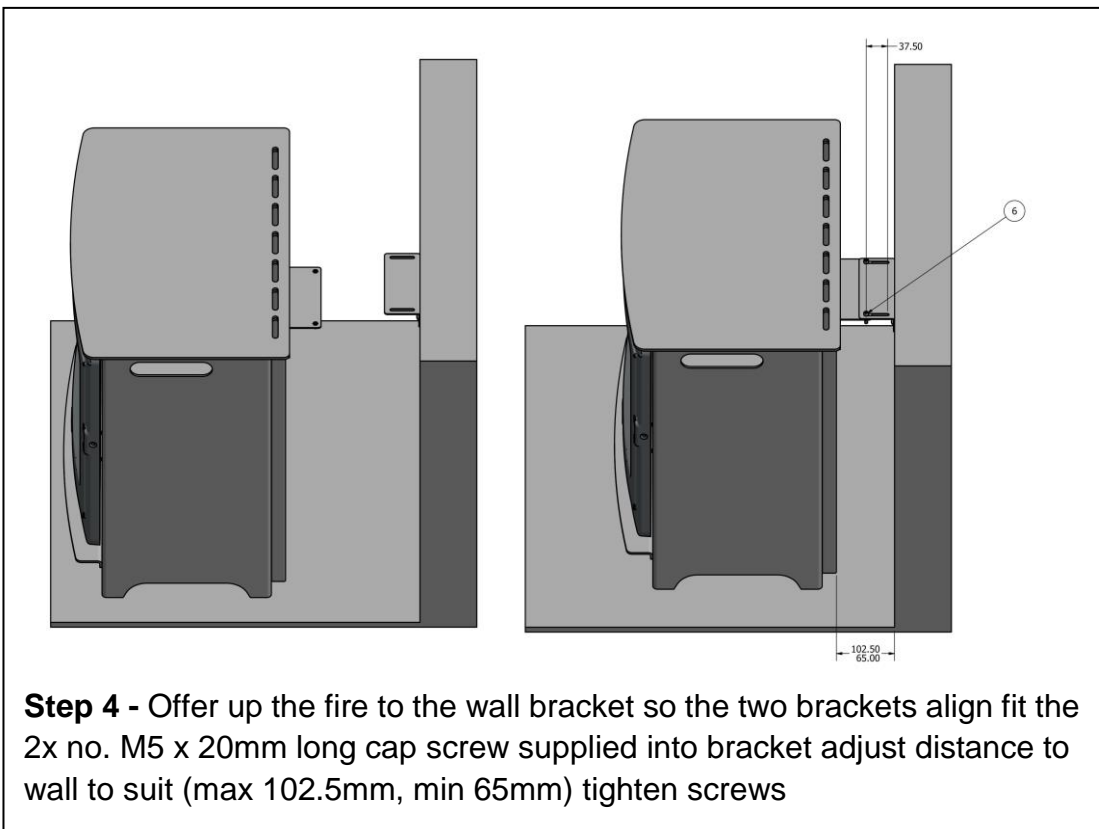
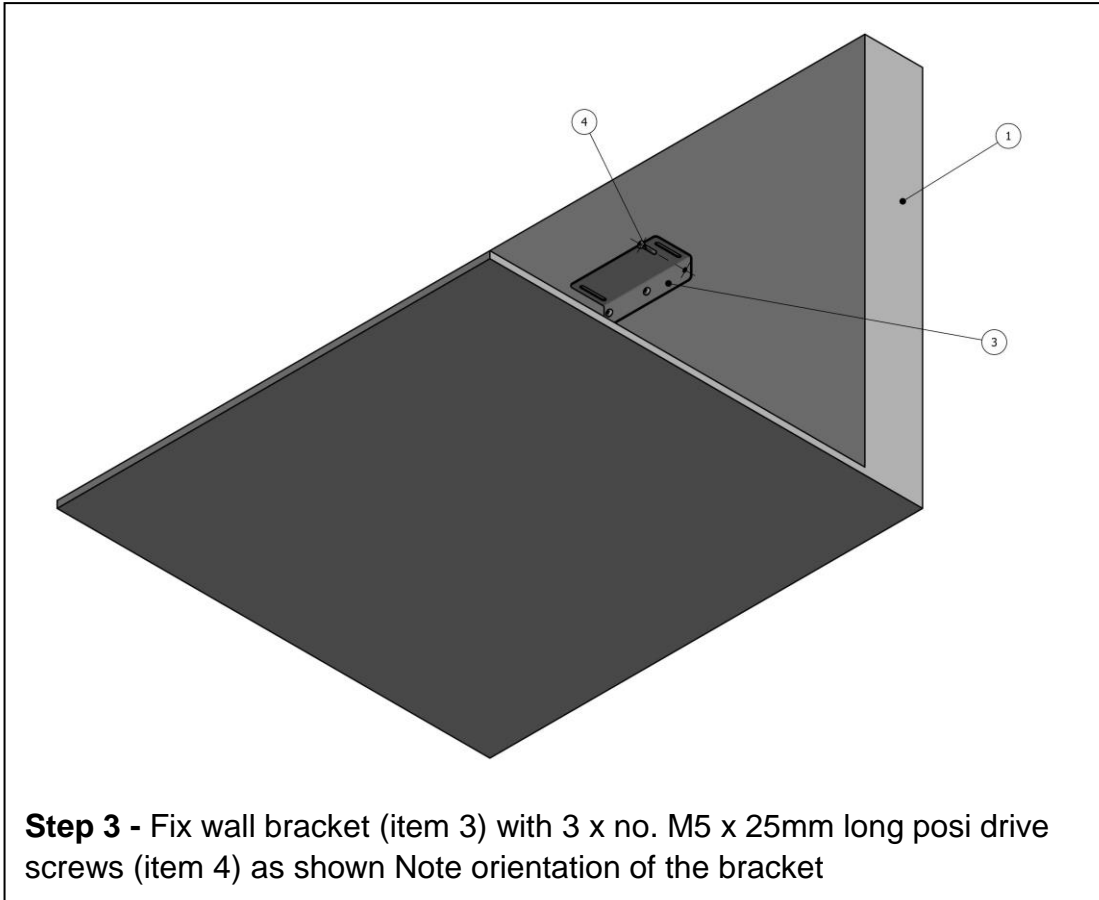

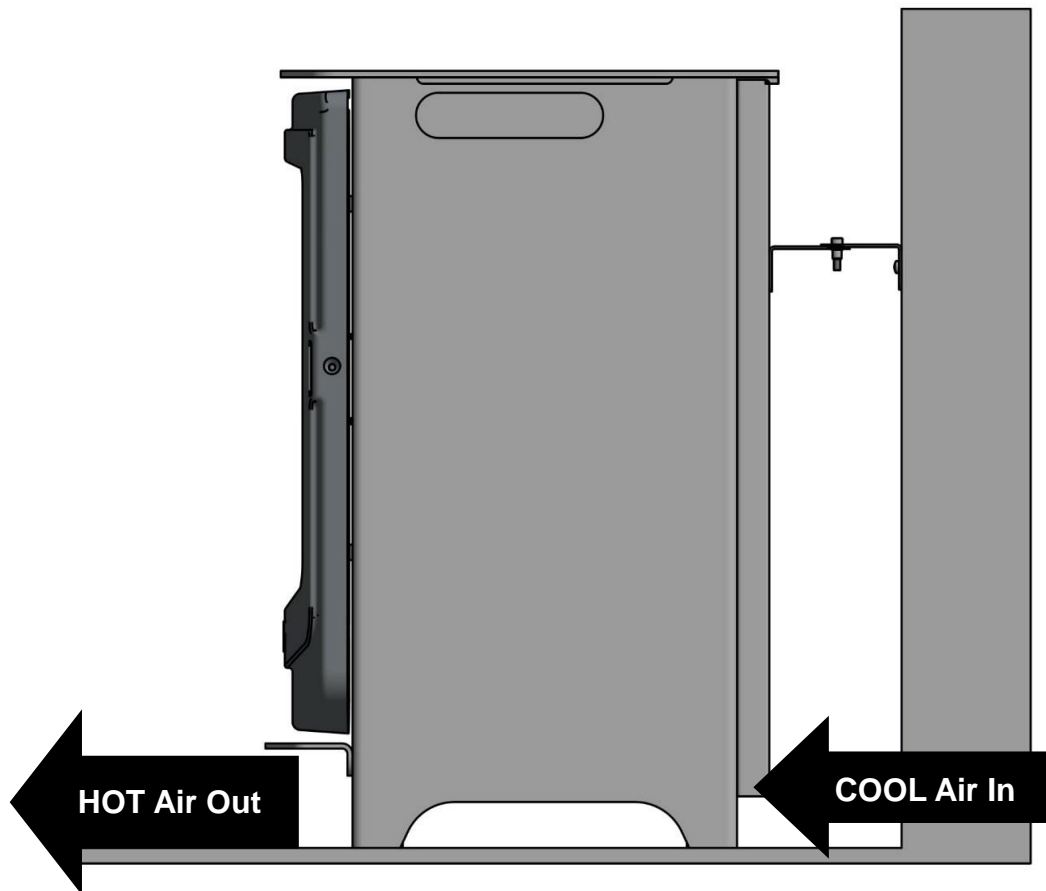

Congratulations the rear fixing bracket is now complete and the stove is securely fixed to the rear wall. Now you can open the door without the possibility of the stove tipping forward and lay your log arrangement

Please note the arrows on the drawing so COOL air enters at the rear of the stove then HOT air comes out from the front of the stove below the door

Please ensure the stove is fitted onto a non-combustible hearth as described earlier in this manual

Please ensure there is 100 mill gap at the rear so COOL air from the room can enter into the rear of the stove without any restriction

IMPORTANT - Please make sure the front Hot Air outlet and the rear Cool Air inlet are regularly cleaned so no foreign matters such as pet hairs and carpet fluff can block these 2 vents

NEVER COVER THIS STOVE – THIS COULD CAUSE A FIRE

Now just plug in your stove using the 3 pin plug lead provided into the female plug socket at the rear of the stove. Please note the 3 pin Plug must be plugged into a wall mounted three pin socket (which is part of your 13 amp ring main) not an extension lead or a multi plug in the wall

SETTING UP THE LOG SET & MEDIA

Your Stove is supplied with 11-piece-log, Amber Glass beads and Black and White Vermiculite chippings.



Large Bag of Amber Glass Bead Embers to be placed onto LED light base of the stove



Small bag of White and Black Vermiculite chippings to place over the logs and Amber glass beads to enhance the real log burning feature



LOG SET - SAMPLE LAYOUT



Stove with the base lights and the rear flame effect turned on - only using the Yellow light option



Step 1 - Now you are ready to place the media and logs into your stove

Firstly pour the bag of amber glass beads onto the glass base plate which will allow the light from the base lights to diffuse and glow



Step 2 - You can lay the logs in what ever pattern or design you wish, there are 11 x logs of various sizes (length and thickness) so from the 11 x logs select the ones you wish to assemble into the stove and arrange them in a manner that suits you.

Also included are the black and white vermiculite chippings you can just sprinkle these over the top of the logs for that final log burner effect













Now just clean the door glass inside and out with a damp cloth, then close the door. The door only needs to be reopened if you wish to change the log arrangement. So for safety reasons keep the door closed

You probably won't want to use all 11 x logs in the fire bed at the same time but keep the extra ones safe as this gives you the option to change the log bed design when you wish

Now sit back and enjoy

OPERATING YOUR STOVE

Understanding the Icons on the Remote Control

ICON	DESCRIPTION OF THE FUNCTION – FULLY DETAILED OVERLEAF
	Red in Colour – this is the Main ON/OFF button for the stove, this will turn on the LED lights and the Heater
	This button operates the LED lights in the base and the rear flame effect turning them on or off, so you can have the heater on, but the lights off
	This Flame icon appears on the remote screen to show the flame effect is working
	This operates the RED coloured LEDs in the base and the red colour in the flame effect in the back of the stove, there are 3 x levels of brightness, High, Medium and Low – each time you press the button the brightness will adjust on the 4 th press of the button this light colour will turn off. You can operate all 3 lights together or just one colour or 2 colours together.
	This operates the YELLOW coloured LEDs in the base and the red colour in the flame effect in the back of the stove, there are 3 x levels of brightness, High, Medium and Low – each time you press the button the brightness will adjust on the 4 th press of the button this light colour will turn off. You can operate all 3 lights together or just one colour or 2 colours together.
	This operates the BLUE coloured LEDs in the base and the red colour in the flame effect in the back of the stove, there are 3 x levels of brightness, High, Medium and Low – each time you press the button the brightness will adjust on the 4 th press of the button this light colour will turn off. You can operate all 3 lights together or just one colour or 2 colours together.
	This button operates the top light colours. There are 16 shades of colour varying from red, green, blue, violet, purple & yellow. If you want you can just have the down lights on without the flame effect
	This is the Fan Heater Button and operates the Heater unit turning it ON/OFF and between the high and low settings
	The Remote control screen displays this icon which means the stove is operating on its High heat setting which is 1900W
	The Remote control screen displays this icon which means the stove is operating on its Low heat setting which is 950W
	Press this button to adjust the temperature setting between 7°C and 30 °C The buzzer beeps when the remote key is pressed;
	This is the Shift Key button to adjust the settings

ICON	DESCRIPTION OF THE FUNCTION – FULLY DETAILED OVERLEAF
	This button operates the Timing Parameter Settings
	This Button operates the Open Window function, this automatically adjusts the room temperature when set up
	This button operates Setting up the Timer Function on the stove
	<p>Time Table indicator for Setting up the Heater Parameter on the Remote Control Screen</p>

Understanding the Icons on the side of the stove for Manual Operation

This touch panel is located on the top right hand side of the stove





	Press this button to turn ON/OFF and adjust the Fan Heater output HIGH/LOW
	Press this button to turn ON/OFF and adjust the brightness of the LED base lights and the rear flame effect. N.B All 3 light colours operate together only from this button
	Side Screen on stove light is RED indicates heater is on the High Heat setting of 1900W
	Side Screen on stove light is BLUE indicates heater is on the Low Heat setting of 950W
	Side Screen on stove light is YELLOW indicates Open Window Function is on
	Side Screen on stove light is GREEN indicates Timer Function is on



MANUALLY OPERATING THE STOVE - INSTRUCTIONS

This touch pad is located on the right hand side of the stove at the top



1 TURNING THE HEATER ON/OFF ONLY – LOW HEAT / HIGH HEAT



Press the  button/key on the touch pad. When pressed for the first time, the heater will work at the High Heat Setting of 1900W, the indicator panel  lights up RED.

Press for the second time, the heater reduces to the Low Heat setting of 950W, the indicator panel  lights up BLUE. Press for the third time, the heating element turns off, the indicator panel light extinguishes. 

Note: After the heating elements are turned on manually, the heating elements will work but are not controlled by the temperature thermostat sensor which is located inside the stove.

2 FLAME EFFECT ONLY – BLUE, RED & YELLOW LED LIGHT OPTIONS





Press key  button/key on the touch pad. When pressed for the first time, the bottom base LED lights and rear flame will light up on their highest brightness setting, this automatically brings on all 3 x light colours Blue, Red & Yellow. Press for the second time, the base LED lights and rear flame are set to their medium brightness. Press for the third time, the base LED lights and rear flame will be in its lowest brightness setting. Press for the fourth time, the base LED lights and rear flame goes out.

- **RED LIGHTS**  - for Real Wood / Coal Flame effect
- **YELLOW LIGHTS**  - for Real Wood Flame effect
- **BLUE LIGHTS**  - usually used for the ICE mood effect

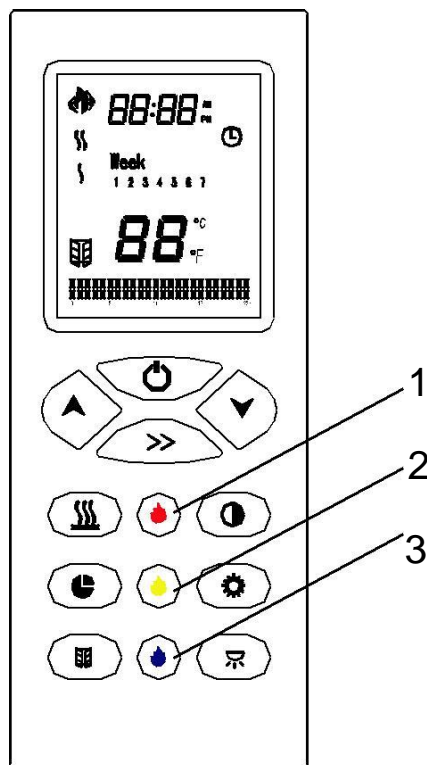
When used in remote control mode you can mix all of the 3 lights and brightness's together or just have one and/or two light colour(s) on independently to set the mood you require in the room

REMOTE CONTROL OPERATION





<p>1</p>	<p>TURNING ON THE STOVE WITH THE REMOTE – HEAT & LIGHTS</p> <p>Press the remote control’s key , the remote screen turns on, the bottom base LED lights and rear flame ignites and the flame icon  appears on the screen of the remote control. The Week, Time (24h system), and Temperature setting are displayed normally. Press it again, the screen of the remote control will turn off. To turn on the heat press the heater button  see refer to point 5 for full details</p>
<p>2</p>	<p>JUST TURNING ON THE LED LIGHTS FOR THE FLAME EFFECT IN THE BASE & REAR</p> <p>Once the stove has been turned on as described in 1 above, you can just operate turning On/Off the bottom base LED lights and rear flame using the  button on the remote control.</p>

3 TURNING ON THE INDIVIDUAL LIGHTS – BASE & REAR FLAME

The 3 x colours can be adjusted in brightness from Low, Medium & High then OFF independently as follows by just single pressing the icon button on the remote below:

Press  (1) to adjust the red flame. The buzzer beeps once when the key is pressed;

Press  (2) to adjust the yellow flame. The buzzer beeps once when the key is pressed;







Press  (3) to adjust the blue flame. The buzzer beeps once when the key is pressed;

You can mix all of the 3 lights and brightness's you require together or just have one and/or two light colour(s) on independently to set the mood you require in the room by just pressing the 3 coloured flame buttons on the remote control

4 TURNING ON/OFF & ADJUSTING THE COLOURS OF THE DOWN LIGHTS



Press the  button to turn on, turn off and adjust the top light colors. The buzzer beeps once when the key is pressed; There are 16 shades of colour varying from red, green, blue, violet, purple & yellow. If you want you can just have the down lights on without the flame effect

5. TURNING ON THE HEATER ONLY – HIGH & LOW HEAT



Press the Heating key . When pressed for the first time, the heating elements works at the High Heat setting of 1900W, the LCD screen displays , the indicator  on the stove lights red. Press a second time, the heating elements reduces down to the Low Heat Setting of 950W, the LCD screen displays , the indicator  on the stove lights blue. Press a third time and the heating elements turns off, the LCD screen does not display the function icon, the indicator  on the stove goes off. The buzzer beeps once when the key is pressed;

Note: in case the heating elements are turned on by remote control, whether the heating elements work or not depends on the temperature setting and ambient temperature. They work only when the temperature setting is above the ambient temperature.













6. AJUSTING THE TEMPERATURE SETTING

Press key   to adjust the temperature setting between 7°C and 30 °C.
The buzzer beeps when the key is pressed;







7. SETTING UP THE REMOTE CONTROL TIME & DAY FUNCTIONS

Press shift key  . Press once, the corresponding figure flashes. Press   now to set current time and week. The buzzer does not beep when the key is pressed

8. SETTING THE TIMER CONTROL





Press timing parameter setting key“  .” Press for the first time and the LCD screen displays  to indicate Monday. Now the temperature setting flashes, press “  “  ” to set the timing temperature for Monday, press key “  ” to confirm and then press “  ” “  ” the time setting for timing. The displayed time parameter is “00-23.” Press “  ” to set the current operating state of timing function;  indicates that the timing is on currently and the control temperature is the temperature setting,  indicates that the timing is on currently and the control temperature is the temperature setting minus 3 °C, No display indicates timing is off currently and the heating elements do not work. Corresponding point flashes when setting. Press for the second time, it displays  , set the parameters for Tuesday. Press for the 7th time and it displays  . Press for the 8th time and it exits and recovers to the current week day;



9. SETTING UP THE TIMING PARAMETER

Press “.” Press for the first time and the timing function turns on, the LCD screen displays , the stove’s indicator  lights green. Press again to turn off, icon  on the LCD screen  goes off. After the timing function is turned on, it works according to the parameter settings. The LCD screen  lights up according to corresponding parameter settings;

Note: when the time, week and timing parameters are changed, you need to switch on-off the timing key to transfer the timing parameters to the machine. After the machine has received them correctly, the buzzer will beep once.

10. SETTING UP THE OPEN WINDOW CONTROL

Press“”. Press once to turn on the Open Window function, the LCD screen displays icon , the indicator  on the stove lights yellow. Press again to turn it off, the LCD screen does not display icon  and the indicator  on the stove goes off. The buzzer beeps when the key is pressed;

After the Open Window function is turned on, the program firstly detects if the heating function is turned on. If it is turned on, the program will save the current ambient temperature value and detects the ambient temperature change once per 12 minutes. When the decrease in the ambient temperature detected within 30 minutes exceeds 4°C, the program will deem that the window is open and stop heating, and the Open Window indicator  on the stove will flash rapidly. After it has stopped heating for 70 minutes, the program starts to detect if the window is closed, and the indicator  flashes slowly. It heats for 6 minutes every 30 minutes (position H2). If the temperature rise is more than 2°C, the window is considered as closed, and the indicator °C stops flashing.



STOVE RESET SEQUENCE

- 1) Unplug the Stove from the wall socket
- 2) Switch the unit OFF on the rocker switch on the side of the stove
- 3) Turn the on/off rocker switch to ON
- 4) Using the remote only turn the display ON
- 5) Does it work?
- 6) Turn the heater on to the low setting
- 7) Does it work?
- 8) Turn the heater on to the high setting
- 9) Does it work?

CARE AND MAINTENANCE

1. Switch off and unplug from the power supply before cleaning.
2. Using a soft, moist cloth, with or without a mild soap solution, carefully clean the exterior surface of the products.

CAUTION: Unplug from the mains electrical supply and allow the product to completely cool before handling or cleaning it.

3. Do not allow water or other liquids to run into the interior of the product, as this could create a fire and/or electrical hazard.
4. We also recommend the periodic cleaning of this appliance by lightly running a vacuum cleaner nozzle over the guards to remove any dust or dirt that may have accumulated inside or on the unit.

5. VERY IMPORTANT - REGULARLY CLEAN THE COOL AIR INLET VENT AT THE BOTTOM REAR OF THE STOVE AND THE HOT AIR OUTPUT VENT AT THE BOTTOM FRONT OF THE STOVE OF ANY FOREIGN MATTERS SUCH AS PET HAIRS, CARPET FLUFF, DUST, DEBRIS OR FIBRES

CAUTION: Do not use harsh detergents, chemical cleaners or solvents as they may damage the surface finish of the plastic components.

ENVIRONMENTAL PROTECTION

RECYCLING



This symbol is known as the 'Crossed-out Wheelie Bin Symbol'. When this symbol is marked on a product or battery, it means that it should not be disposed of with your general household waste. Some chemicals contained within electrical/electronic products or batteries can be harmful to health and the environment.

Only dispose of electrical/electronic/battery items in separate collection schemes, which cater for the recovery and recycling of materials contained within. Your co-operation is vital to ensure the success of these schemes and for the protection of the environment.

REPLACEMENT PARTS FOR THE ELECTRIC FIRE BOX ONLY

NO	PART NUMBER			DESCRIPTION	QTY.
	Ellesmere ECE Standard	Ellesmere ECE Wide	N/A		
1				TOP PANEL	1
2		602065D		BLOWER AND HEATER ASSEMBLY	1
3		601094F		CIRCUIT BOARD	1
4				FIREPLACE BOX	1
5		10104010		SWITCH	1
6		601035		CONTROL PANEL	1
7		301506		REMOTE RECEIVER	1
8	601141		601141	FLAME LED STRIP	1/0/1
9		601142			0/1/0
10	10702244	10702246	10702249	BOTTOM GLASS	1
11		10125025		CANOPY LIGHT	1
12		10101221C		FLAME MOTOR	2
13	3215505	3216505	3217505	FLICKER ASSEMBLY	2
14	10702245	10702247	10702248	BACK GLASS	1
15	601136B		601136B	TRAY LED STRIP	1/0/2
16		601137B			0/1/0
17		10105203		REMOTE CONTROL	1

EXPLODED VIEW & PARTS LIST

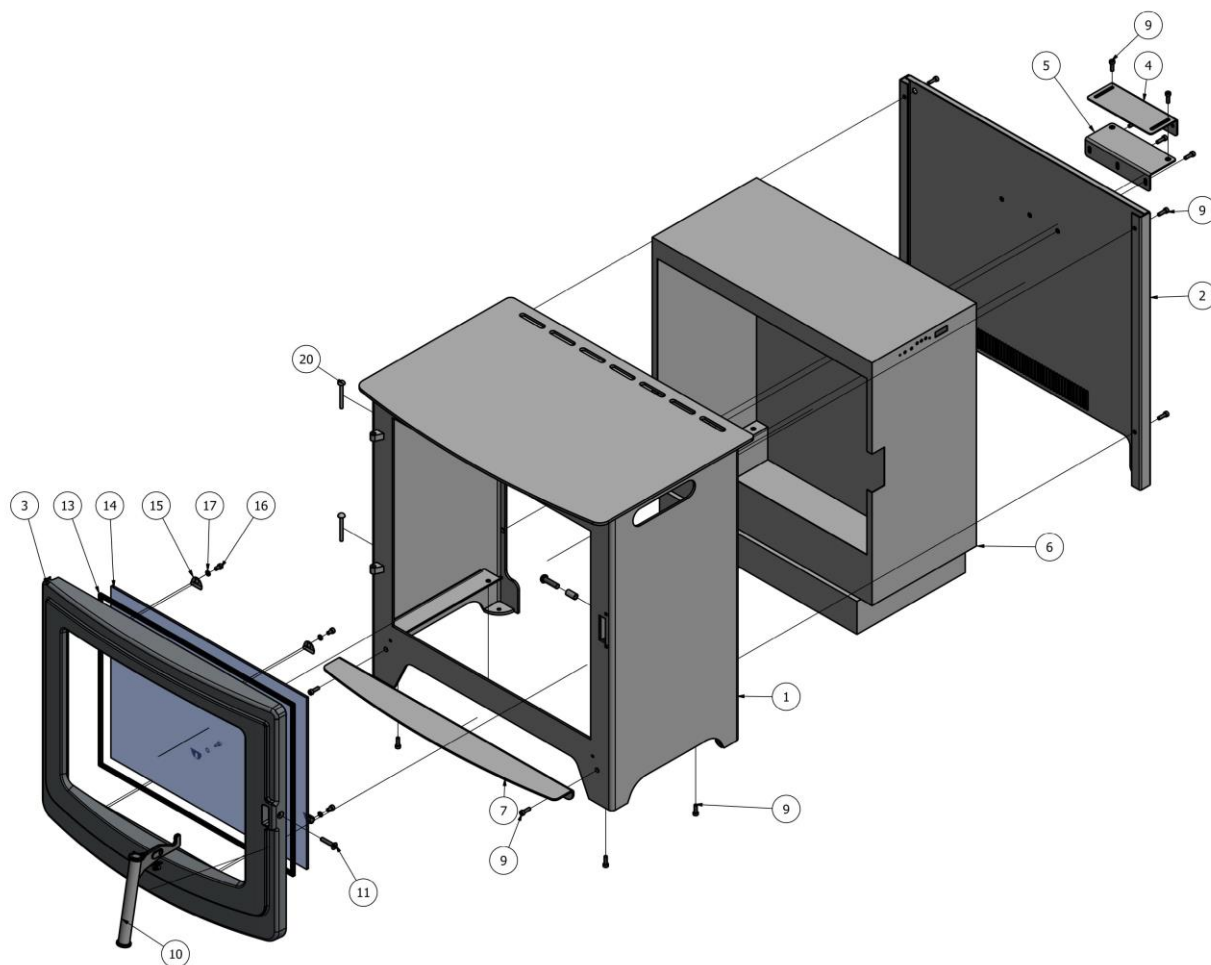

Reference	Qty	Description	Part Number
1		A5E Main Body	10500
2		A5E Rear Heat Shield	10501
3		A5 Cast Door	10502
4		Wall Mounting Bracket 1	10503
5		Wall Mounting Bracket 2	10504
6		EC5 Electric Firebox Assembly	10505
7		Front Ash Lip	10506
8 & 9	6	M5 X 15 CAP SCREW	10507
10	1	Handle Assembly	10508
11	1	M6 CSK x 30mm Screw Handle Pivot	10509
12		M6 CSK x 25mm Screw	10510
13		A5 Glass Gasket	10511
14		A5 Standard Electric AGA Glass	10512
15, 16 & 17	4	Glass Clips & Fixing Screws & Washers	10513
18 & 19	1	Handle Roller and Fixing Screw	10514
20	2	Door Hinge Pins	10515



TROUBLE SHOOTING

PROBLEM	POSSIBLE CAUSE	SOLUTION
Dim or no flame	Flame LED's are burnt out	Inspect the LED's and replace them if necessary
	Back black cloth is falling off and roll the flicker	Change a new flicker and back black cloth
Ember bed is not glowing or dimming	Ember LED's are burnt out	Inspect the ember bed LED's and replace them if necessary
Appliance turns off and will not turn on	Appliance has overheated and safety device has caused the thermal switch to disconnect	Turn off the main switch, allow appliance to cool for 10 minutes, then turn it on
	House circuit breaker has tripped	Reset house circuit breaker
	Appliance's fuse has blown	Replace the fuse
Appliance will not come on when switch is flipped to ON	Appliance is not plugged into an electrical outlet	Check plug and plug in
	Appliance has overheated and safety device has caused the thermal switch to disconnect	Turn off the main switch, allow appliance to cool for 10 minutes, then turn on
	Circuit board is burnt out	Inspect the circuit board and replace if necessary
No warm air coming out of appliance	Heater is burnt out	Inspect the burner and heater assembly and replace if necessary
Flame sputters	Flame motor is defective	Call a qualified service technician and replace flame motor
Remote Control does not work	Low batteries	Replace AAA batteries in remote control
	Unit switch in "O" position	Turn the switch in "I" position
Flame is fixed	Wiring may be loose or the flame motor may be defective	



SERVICE HISTORY

This heater must be serviced annually depending on usage.

Date	Dealer Name	Service Technician Name	Service Performed	Special Concerns

NOTES:



AGA FREESTANDING ELECTRIC STOVE – 2 YEAR EXTENDED WARRANTY

If you have purchased your stove from an authorised stockist within our Retailer Network, then automatically your product will carry an extended 2 year warranty. You do not need to register your stove for the warranty, but you need to retain your invoice as proof of purchase, as you will need this to make a warranty claim. So please keep the purchase invoice/receipt safe, you will also require the serial number of the stove which is on an aluminum plate above the bottom door hinge, so open the door and you will see it. This allows us to trace the date the stove was manufactured and which retailer it was sold to. Any warranty claims have to be dealt with by the retailer you purchased the stove from, the retailer will then contact AGA to deal with any warranty claims

Any product purchased outside of our Premium Retailer Network will carry a standard 12 month, non-extendable warranty.

It is a condition of the Extended Warranty that the installation complies with relevant Building Regulations and the rules in force, and is carried out by a suitably trained and qualified/competent person and the freestanding stove is installed as detailed in the installation and operating manual, ensuring the stove has ample ventilation completely around the stove.

This warranty is not transferable and is extended only to, and solely for, the benefit of the original purchaser of the stove. Please retain your dated sales invoice/receipt as a proof of purchase. During your extended warranty period, only genuine spare parts must be used in the servicing and maintenance of your stove, these spare parts can be ordered via the Premium Retailer directly. Consumable items such as glass, paint, screens, door rope seals, bulbs, LED light boards, ceramic/plaster fuel effects, remote controls, glass beads and batteries which are either subject to normal wear and tear or parts that require replacement in connection with normal maintenance and are not covered, either by the original or the Extended Warranty. Should you experience problems with your stove, any claim must be submitted to warranty@agastoves.org.uk with details of the supplying retailer and installation partner.

Warranty Exclusions and Limitations

No Warranty is extended to consumable service parts. Repair or replacement of parts which are subject to normal wear and tear during the warranty period or parts that will require replacement in connection with normal maintenance. Such parts include but are not limited to glass, screens, bulbs, LED boards, ceramic fuel effects, glass beads and batteries.

Additional Advisory Information

Please do not cover this stove in anyway what so ever with anything as this could cause damage to the stove and void any warranty

You must fit the stove in accordance with the manufacturer's instructions and regularly clean any dust, fibres or debris (Pet hairs & Carpet Fluff) from the fan heater inlet and outlet as this could cause damage or become a fire risk. This stove must be installed on a non-combustible hearth with the correct clearance around it so air flow can move around the stove freely as detailed in the installation manual



The Extended Warranty does not cover:

- a) In normal usage the paint finish of your Stove may change colour slightly. As these circumstances are considered normal, they are not covered by the warranty.
- b) Enamelled components where these parts are subjected to abnormally high temperatures, chemical abrasion or thermal shocks, resulting in chipping, cracking, bubbling or discolouration and crazing of the enamelled finish.
- c) Damage resulting from installation and usage where the appliance has not been installed or used in accordance with the Stoves installation and operation instructions, or if the installation does not conform to local building, fire and safety regulations.
- d) Defects or faults caused by specific local conditions such as draught problems, water damage and condensation (including the remote control unit)
- e) Damage caused by unauthorised modifications, use or repair.
- f) Damage or defects caused by the product being stored in a damp, unheated environment.
- g) Consequential loss (to the extent permitted by law) relating to other associated products that have not been supplied by AGA Stoves.
- h) Consequential loss (to the extent permitted by law) related to decorations, furnishings or other household assets.
- i) Delivery to/or return transport costs, Removal and re-installation costs. or any labour cost to fit parts

Repaired or replaced products are covered only for the remainder of the original warranty period.

If you should ever wish to make a warranty claim because of a product fault or defect, you must inform us within a reasonable amount of time, this is within 14 days from the date on which the fault or defect first became apparent. If the product fault or defect is notified after 14 days from the date on which the fault or defect became apparent, we cannot accept any liability for events or issues which arise after the 14 day period or which are caused or increased by the lack of notification which therefore prevented action being taken to restrict or eliminate any consequences arising from the fault or defect at an earlier date.

In the event of a product fault occurring during the warranty period, we will send the appropriate components or goods necessary to rectify the fault, free of charge. but this does not cover any labour cost to fit them.

Nothing in the Extended Warranty shall make AGA Stoves or their partners liable for any or special, incidental or consequential damages, injury to persons or property, or any other consequential loss beyond the consumer's statutory rights. The liability on AGA Stoves total liability extends only to the purchase price paid for the goods by the Premium Retailer, except where such a limitation is prohibited by statute. AGA Stoves, in the event of a warranty claim, reserve the right to either replace the goods in question or to refund the purchase price of the goods as paid by the Premium Retailer.

The Extended Warranty does not affect your statutory rights.

The above warranty terms and conditions came into effect on 1st January 2013 and are applicable for all relevant products purchased after this date. Please note: This warranty is applicable for purchases within the United Kingdom (mainland only).



AGA Rangemaster
Station Road, Ketley
Telford, Shropshire
TF1 5AQ
United Kingdom
www.agastoves.co.uk



**BRITISH
MADE**

**This Stove has been fully CE Tested, Approved
& Manufactured in the UK**



This stove conforms to all relevant European Directives

With AGA Rangemaster's Policy of Continuous Product Improvement, the Company reserves the right to change specifications and make modifications to the appliance described and illustrated at any time